

COMMERCIAL  
SPECIFICATION  
CATALOG





Pioneer Water Tanks manufactures tanks from 3,856 gallons to 703,126 gallons capacity with structural engineering suitable for rural, domestic or commercial use using durable and 100% Zincalume steel.

Any Pioneer Water Tank can be designed to suit earthquake zones, cyclonic regions, heavy industrial or highly specialized environments.

Our tanks feature the innovative and aesthetically pleasing 8-80 V-LOCK profile with protective capped bolt system and fully enclosed vertical bolt cover for optimal strength and structural integrity.

## OUR COMMITMENT

### Pricing

Committed to providing a competitive price and personalized service to match individual needs.

### Experience

Dedicated staff with practical knowledge and years of experience.

### Flexibility

We listen to your specific needs and recommend a suitable custom water storage solution.

### Engineering

Through our qualified engineering personnel and independent consultant engineers, we provide high quality professional design and support services.

### Installation

Thorough check methods are employed to ensure correct installation from beginning through to commissioning. Our procedures provide for ease of installation, less time on site, minimal infrastructure and construction personnel.

### Distribution

Pioneer Water Tanks is the exclusive Master Distributor of Pioneer Water Tanks for North America.

### Quality & Service

Pioneer Water Tanks are committed to providing the best quality product and service from first contact to completed and tank and after sales service.

### Aesthetics

Profiled wall design and wide range of colors to seamlessly integrate with the surrounding environment.

### Advanced Production Technologies

Continual research and development and innovative production methods create uniform quality. A culture of continuous improvement forms a key pillar of Pioneer Water Tanks' business success.



# GROSS CAPACITY CHART

Tank model	Tank diameter	Number of rings/Wall height with Gross Capacity in Gallons							
		R1 3 ft 9 in	R2 7 ft 2 in	R3 10 ft 7 in	R4 14 ft	R5 17 ft 5 in	R6 20 ft 10 in	R7 24 ft 3 in	R8 27 ft 8 in
XL01	8 ft 10 in	1,714	3,249	4,813	6,363	7,913			
XL04	11 ft	2,678	5,076	7,521	9,942	12,364	14,786		
XL05	13 ft 2 in	3,856	7,309	10,830	14,317	17,804	21,291	24,778	
XL08	15 ft 5 in	5,226	9,907	14,678	19,404	24,130	28,856	33,582	
XL10	17 ft 7 in	6,829	12,946	19,182	25,358	31,534	37,710	43,886	
XL13	19 ft 9 in	8,647	16,392	24,287	32,107	39,927	47,747	55,567	63,387
XL15	22 ft	10,679	20,243	29,994	39,651	49,309	58,966	68,624	78,281
XL20	24 ft 2 in	12,925	24,501	36,302	47,991	59,680	71,368	83,057	94,746
XL23	26 ft 4 in	15,347	29,093	43,105	56,984	70,863	84,742	98,621	112,500
XL25	28 ft 7 in	18,018	34,156	50,608	66,903	83,198	99,492	115,787	132,082
XL30	30 ft 9 in	20,904	39,626	58,713	77,617	96,521	115,426	134,330	153,234
XL35	32 ft 11 in	24,004	45,502	67,419	89,126	110,834	132,542	154,249	175,957
XL40	35 ft 2 in	27,318	51,785	76,727	101,431	126,136	150,841	175,545	200,250
XL45	37 ft 4 in	30,792	58,370	86,484	114,330	142,177	170,023	197,869	225,715
XL50	39 ft 6 in	34,588	65,567	97,148	128,427	159,707	190,987	222,267	253,546
XL60	41 ft 8 in	38,545	73,068	108,261	143,118	177,976	212,834	247,692	282,550
XL65	43 ft 10 in	42,652	80,853	119,796	158,368	196,940	235,512	274,084	312,656
XL70	46 ft	46,900	88,906	131,727	174,141	216,555	258,968	301,382	343,796
XL80	48 ft 3 in	51,630	97,872	145,012	191,703	238,395	285,086	331,777	378,468
XL85	50 ft 5 in	56,367	106,852	158,317	209,292	260,267	311,242	362,217	413,192
XL90	52 ft 8 in	61,465	116,515	172,635	228,221	283,806	339,391	394,977	450,562
XL100	54 ft 10 in	66,703	126,446	187,349	247,672	307,995	368,318	428,641	488,964
XL110	57 ft	72,073	136,626	202,432	267,611	332,790	397,970	463,149	528,328
XL120	59 ft 2 in	77,737	147,363	218,340	288,642	358,943	429,245	499,546	569,848
XL130	61 ft 5 in	83,615	158,506	234,850	310,468	386,085	461,702	537,320	612,937
XL140	63 ft 7 in	89,708	170,055	251,962	333,089	414,216	495,343	576,470	657,597
XL150	65 ft 9 in	95,919	181,829	269,406	356,150	442,894	529,638	616,382	703,126

**Note:**

Allowance must be made for air gap and pipe work positioning to establish usable tank volume.

\* Availability subject to site conditions.

**Conversion units**

1 US Gallon = 3.785 Litres

1 Foot = 0.3048 Meters

1 Inch = 2.54 Centimeters

**Legend**

ft = feet

in = inches

# COLORS

## Pioneer Water Tanks Standard Tank Color Range



CLASSIC CREAM™



MANGROVE™

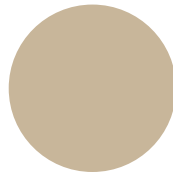

PAPERBARK®



SURFMIST®

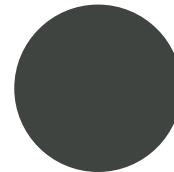

WOODLAND GREY™

## Colorbond® Standard Color Range

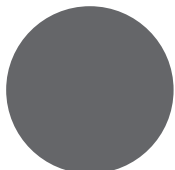

BASALT™



COVE™

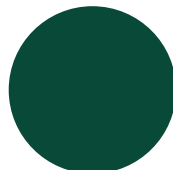

COTTAGE GREEN®

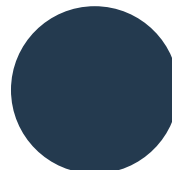

DEEP OCEAN®

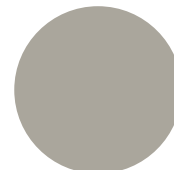

DUNE®

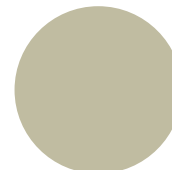

EVENING HAZE™

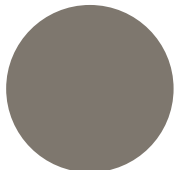

GULLY™

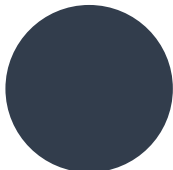

IRONSTONE®

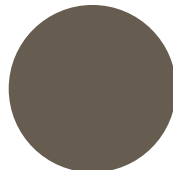

JASPER®

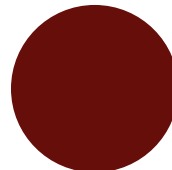

MANOR RED®

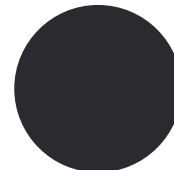

MONUMENT®

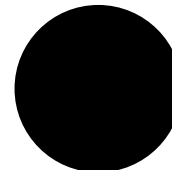

NIGHT SKY®

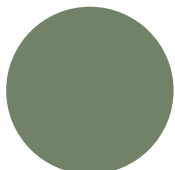

PALE EUCALYPT®

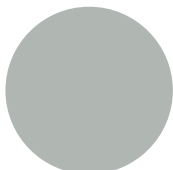

SHALE GREY™

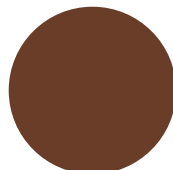

TERRAIN™

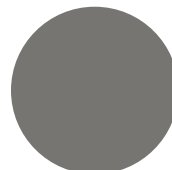

WALLABY™

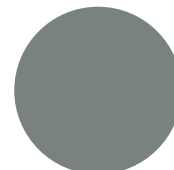

WINDSPRAY®

# TANK DATA SHEET

### Wall structure

Bluescope ZINCALUME® steel, COLORBOND® steel or COLORBOND® Ultra steel panels complying with AS1397. Most severe earthquake loads to AS1170.4. 8-80 V-LOCK wall profile to AS4600.

### Steel grade

G300 ZINCALUME® steel.

### Protective coating

ZINCALUME® steel (zinc/aluminium/magnesium alloy) AM125 heavy-duty coating. Also available in COLORBOND® steel.

### Bolting specification

M10 – M16 galvanized, flanged head, high tensile bolts.

### Dome roof

- Bluescope ZINCALUME® steel, COLORBOND® steel or COLORBOND® Ultra steel.
- Custom orb profile.
- 0.42bmt thickness.
- High tensile G550.
- Hot dipped fully self supporting galvanized roof trusses.

### Nozzles

Nozzles are manufactured from either PE100 SDR17 HDPE or hot dipped galvanized steel (available on request).

### Manufacturing and installation

This can be either client or tank specific or both. Each project will be confirmed in writing and comprise a full installation, manufacturing and installation schedule. Note that Pioneer Water Tanks requires certain information prior to commencing manufacturing. This will be advised to you at the time of proposal.

# GENERAL ARRANGEMENT EXAMPLES (XL10 – XL150)

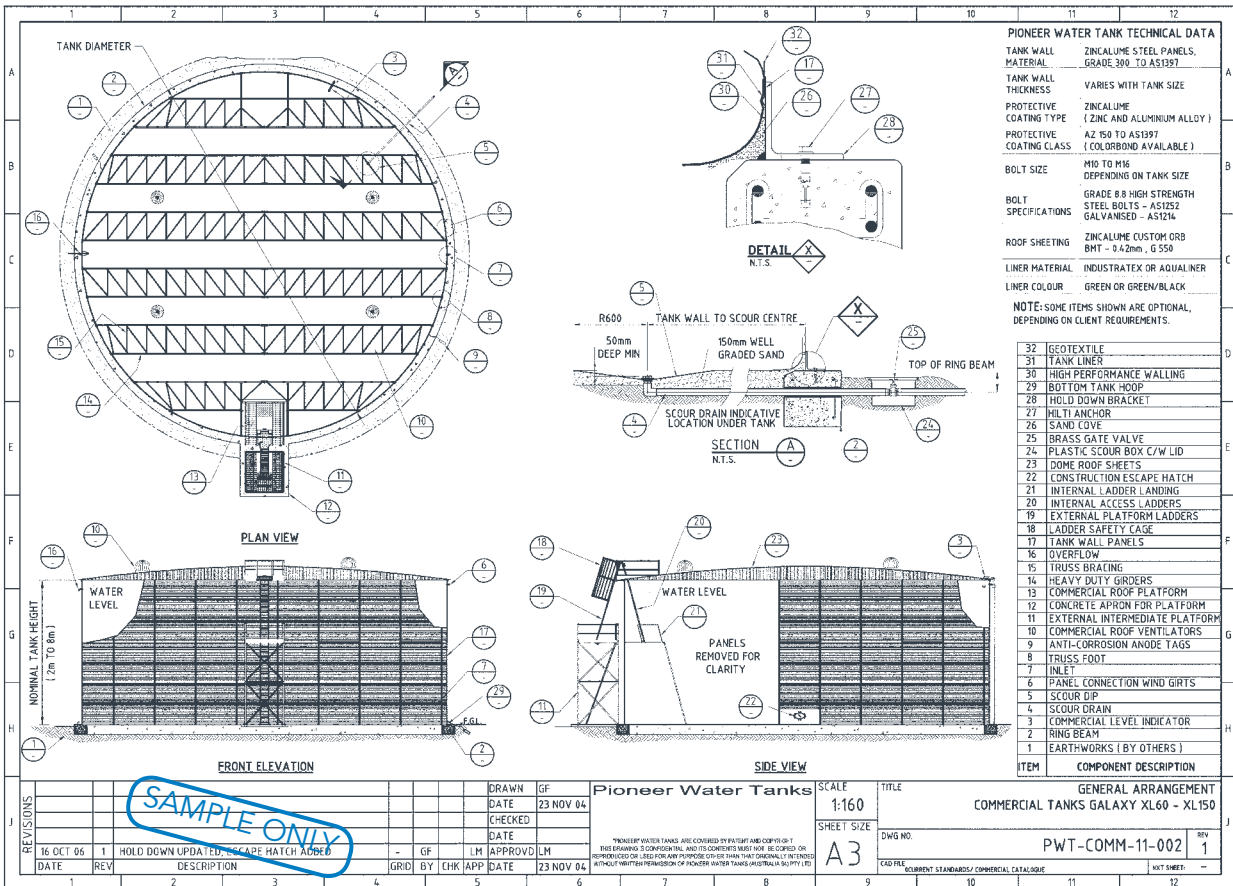
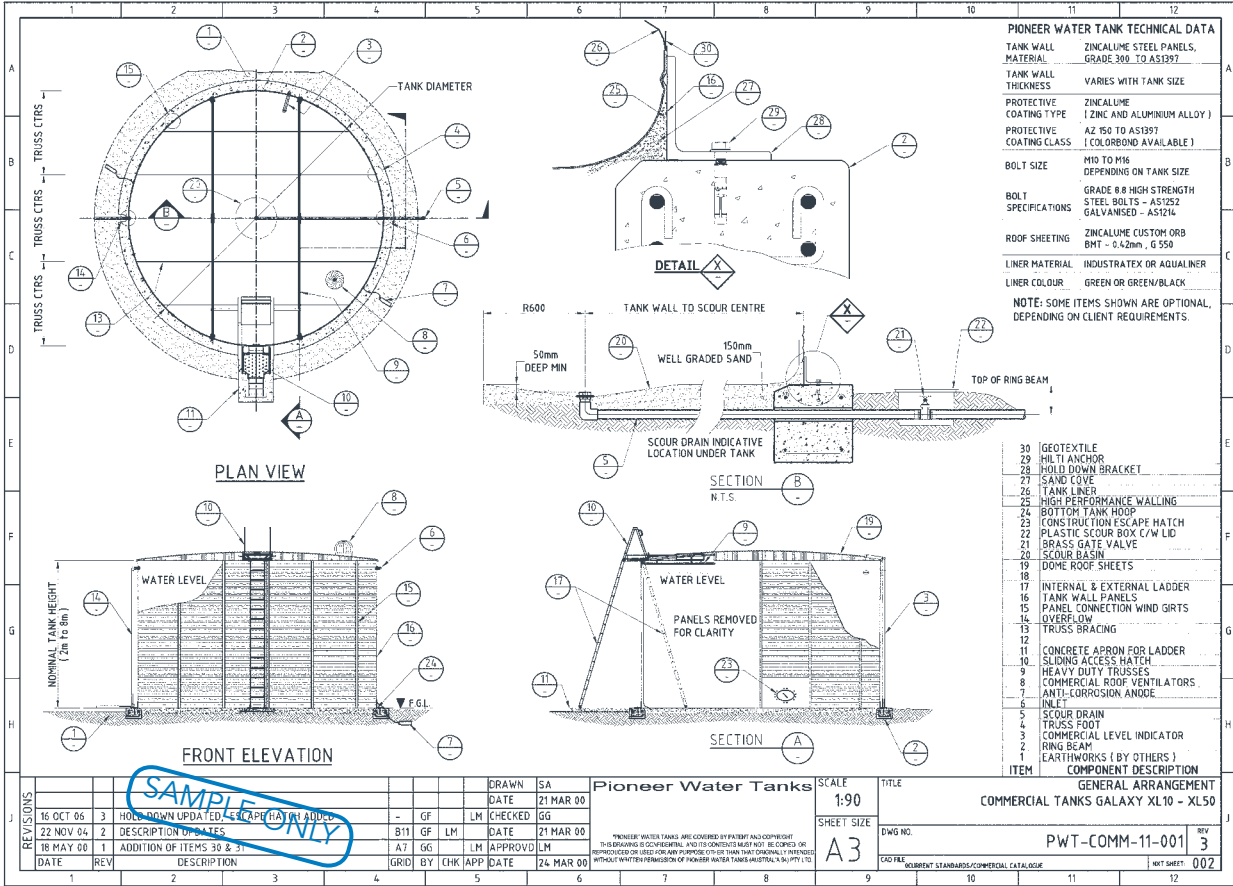

## The 8-80 V-LOCK ADVANTAGE

Pioneer Water Tanks' unique 8-80 V-LOCK is the result of rigorous research and development.

The 8-80 V-LOCK profile is designed to minimize stress on the liner during tank level cycling.

Specifically engineered with a flat section at the bolted panel connections, the 8-80 V-LOCK vastly improves the structural integrity and overall aesthetic appeal of your finished tank.



## UNIQUE SECURED LINER



Pioneer Water Tanks understands the importance of the longevity of your tank liner.

All Pioneer Water Tanks liners are uniquely secured to the tank wall at multiple points to provide optimal support for the liner. This support prevents the liner from pulling away from the tank wall and secures it in position.

The result: less stress on the liner and prolonged service life of your tank.

# TANKLINERS

Aqualiner® and Industratex® have been exclusively developed and manufactured for Pioneer Water Tanks to provide to provide a water tight liquid storage membrane.

Strength, flex resistance, abrasion resistance, chemical resistance, water proofing and leak proofing have been considered in the design of Aqualiner® and Industratex®. Both liners can be custom manufactured for the relining of existing concrete, steel and other types of water tanks.

Primarily intended for potable water storage, your tank liner can be adapted for a variety of non-potable water grades including grey treated, bore, ground or well water.

## Liner Terms and Definitions

### Tensile strength:

Strength of material, measured by tensioning a 50mm wide sample in both directions - warp and weft. Result is the force measured in Newtons (N) at the point at which the material breaks.

### Elongation:

During tensile test a stretch measurement is taken prior to material breaking.

### Warp:

Threads stretched in a loom.

### Weft:

Threads that cross the warp.

### Wing tear:

Force (N) necessary to tear a sample of the material in the warp and weft weave direction. Warp test is measured by tearing in the weft direction and visa versa for the weft tear.

### Tongue tear:

Similar test to wing tear, parallel cuts are made to the material to create a "tongue". Force (N) is applied tearing the material. Warp is measured by tearing in the weft direction and visa versa for the weft tear.

### Coating adhesion:

Force (N) needed to separate a 50mm wide sample lamination (coating) from the weave.

### Flex cracking:

Measured by flexing material until it deteriorates (measured in cycles).

### UV stabilization:

Ability of material to withstand continuous exposure to UV light.

### Flume (water proof) test:

A fabricated test sample (tube is increasingly pressurised with water until the material leaks. Measurement and inspections are conducted at regular intervals and recorded.

### Abrasion resistance:

Ability of the material to withstand abrasive contact.

# AQUALINER® DATA SHEET

This data sheet sets out the criteria for evaluating the suitability of the Aqualiner® as a core component of the liner tank system.

## Approvals

- American Standard: NSF/ANSI Standard 61 - Drinking Water Approval. Certificate 3A240-01.
- British Standard: BS 6920 - Suitable for use in contact with potable water.  
Tested by Water Regulations Advisory Scheme, test report: MAT/LAB 356M, 607M & 608M.

## Specifications and data

### Material make up:

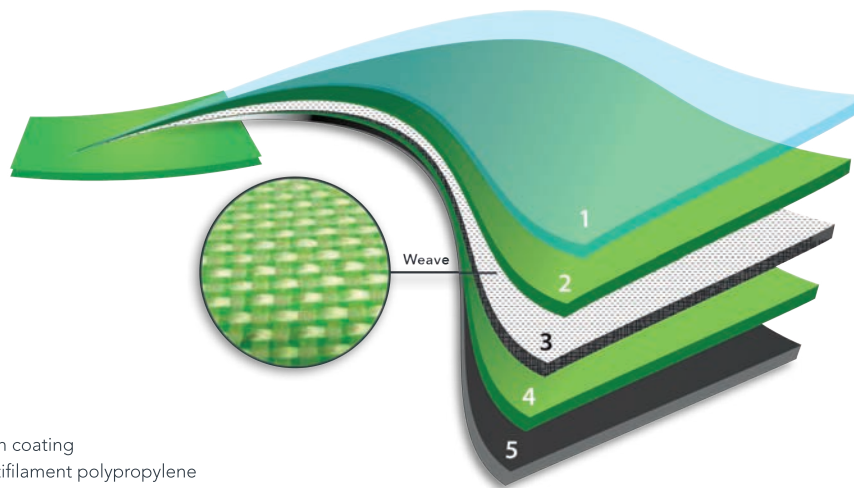

- Layer 1 Clear polyethylene film
- Layer 2 Green advanced polyolefin coating
- Layer 3 Weave: High tenacity multifilament polypropylene
- Layer 4 Green advanced polyolefin coating
- Layer 5 Black polyethylene film

### Tensile strength:

Newtons per 50mm  
(AS2001.2.3)  
Warp: 1901 N  
Weft: 1353 N

### Elongation at break:

(AS2001.2.3)  
(AS4878.6 – method 1)  
Warp: 24.8%  
Weft: 18.8%

### Wing tear:

Newtons per 50mm  
(AS2001.2.10)  
(AS 4878.7 – method A2)  
Warp: 255 N  
Weft: 135 N

### Coating adhesion:

Newtons per 50mm  
(AS4878.2 – preparation 2)  
75-85 N

### Flex cracking:

(AS4878.9 – method B),  
97,000 cycles

### Max/min temperature:

-22° F to +158° F

### UV stabilisation:

Both faces have UV resistance and therefore may be exposed to the sun. However excessive exposure and temperature may dry and shrink the material.  
It is Pioneer's recommendation that the Aqualiner® be covered.

### Material thickness:

0.60mm

Unit mass/weight (AS4878.2):  
405 grams per square metre.

### Seam weld:

25mm weld with 25mm seal tape welded to both sides covering edges of fabric.

### Flume test:

Water beads: 20 metres of water head pressure.  
Burst: 20 metres of water head pressure.

### Chemical resistance:

Aqualiner® is resistant to various chemicals. To be certain, we recommend a chemical analysis report be completed to confirm suitability.

pH: 5 - 10

Chlorine: 3 -5ppm

Note: Intense levels of chlorine such as shock treatment and tablets can have an adverse affect on the Aqualiner®. It is therefore recommended controlled dosing systems be used.

### Special comments:

Aqualiner® can store a wide variety of non-aggressive and aggressive waters however you should also be considerate that the steel structure may not be so readily accepting.



# INDUSTRATEX® DATA SHEET

This data sheet sets out the criteria for evaluating the suitability of Industratex® as a core function of the liner tank system.

## Approvals

- American Standard: NSF/ANSI Standard 61 - Drinking Water Approval. Certificate 3A240-02.

## Specifications and data

Material make up:

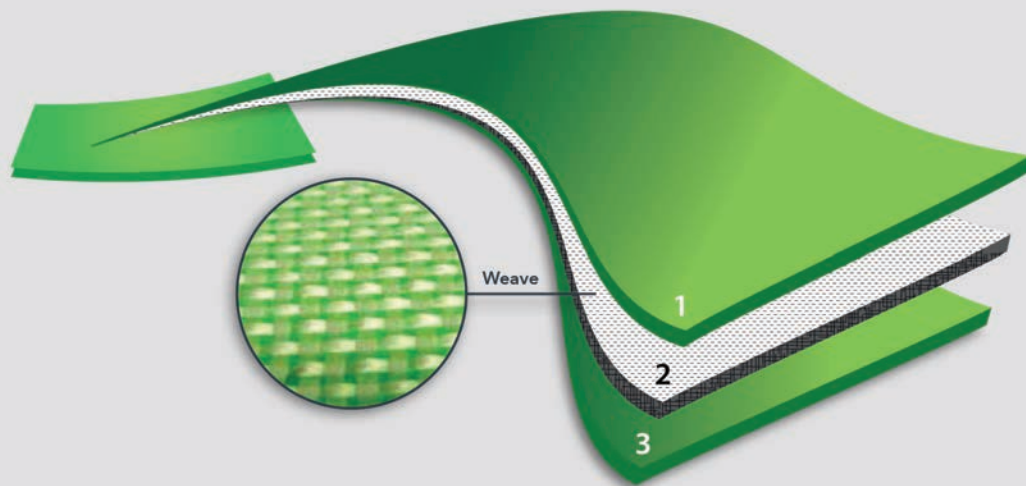

Layer 1 - Green PVC film  
Layer 2 - Polyester weave  
Layer 3 - Green PVC film

### Tensile strength:

Newtons per 50mm  
(AS2001.2.3)  
Warp: 2600 N  
Weft: 2400 N

### Tongue tear:

Newtons per 50mm  
(BS3424.5)  
Warp: 550N  
Weft: 450N

### Coating adhesion:

Newtons per 50mm  
(AS1441.1973)  
90 N (min)

### Flex cracking:

(AS 1441.6)  
400,000 cycles

### Max/min temperature:

-4° F to +122° F

### Stabilisation:

Material is UV stabilised therefore may be exposed to the sun. Excessive exposure and temperatures may dry and shrink the material. It is Pioneer's recommendation that all Industratex® liners be covered.

### Material thickness:

0.06cm

### Unit mass/weight:

610 grams /m<sup>2</sup>

### Seam weld:

2.5cm weld

### Flume (water proof) test:

Water beads: 65.62 feet of water head pressure.  
Burst: 82.02 feet of water head pressure.

### Chemical resistance:

Industratex® is resistant to various chemicals, but to be certain if suitable for your application we recommend a chemical analysis report be forwarded to confirm.

pH: 5 - 10

Chlorine:

Maximum 50ppm

Note: intense levels of chlorine such as shock treatment and tablets can have an adverse affect on the Industratex®. It is therefore recommended that controlled dosing systems be used.

### Recommended applications:

All water storage: potable, ground, bore well, water, river, spring water and seawater.

### Special comments:

Industratex® can store a wide variety of non aggressive and aggressive waters however you should also be considerate that the steel structure may not be so readily accepting.

# ROOF OPTIONS

Pioneer Water Tanks has invested extensive effort developing a roof structure that is not only easy to install but stronger and easily adaptable for most applications.

The innovative truss foot connection allows a flush strong bolted connection with the tank wall, resulting in direct load transfer from roof structure to tank wall and then to the ground.

All roof structures utilize the strength of square hollow sections (SHS), fully welded and post galvanized to build a strong, robust structure that will perform in all conditions.

Additionally, all dome roof structures are carefully engineered to achieve load paths of uniform capacity to maximize cost efficiencies.



# ROOF OPTIONS: INDUSTRY STANDARD

This is a robust engineered roof structure comprising SHS tube members fabricated into welded roof trusses with swivel truss feet to enable secure alignment with the tank wall.

The SHS trusses are high strength/ high ductility and are engineered to provide direct load paths for all loads that are incident to the roof into the tank wall. The structure is typically galvanized to ensure excellent performance and long life. The roof structure is capable of handling construction and maintenance loads as required by AS1170.1.

As with most light building-type structures, personnel need to restrict their footprints to the lines of the trusses. This roof is suitable for most applications where standard access hatches are required, and when not located in an exposed area subject to gales. These roofs are designed in accordance with the relevant clauses of AS1170.0, AS1170.1 and AS1170.2, and can withstand regional wind speeds of up to 141.08 feet per second, as specified in AS1170.2.

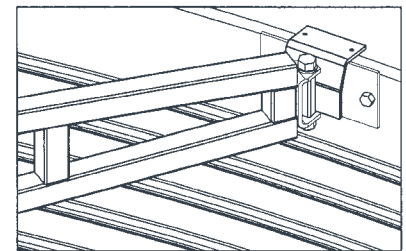
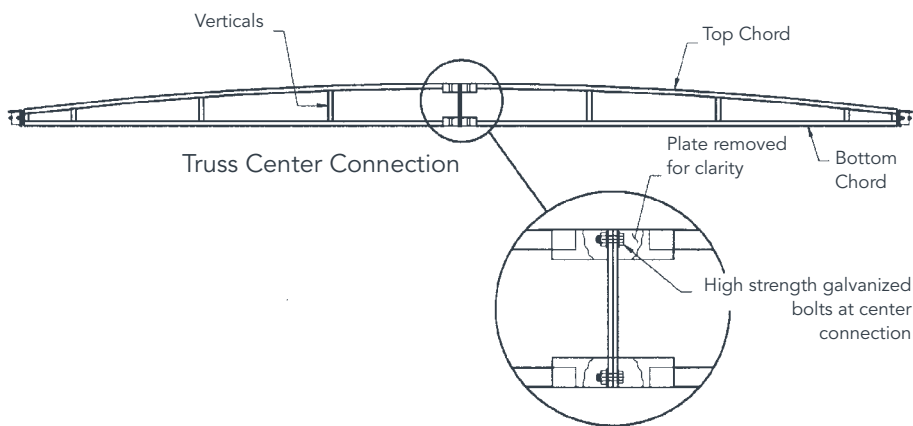

View of truss connection to tank wall from inside

Pivoting action of truss enables correct alignment with tank wall, no matter where the truss lands

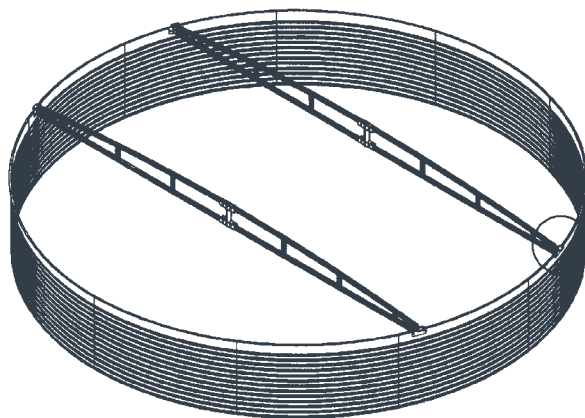

Plan of Tank

Engineered roof structure design assures properly proportioned structural elements and load transfer from the roof to the ground.

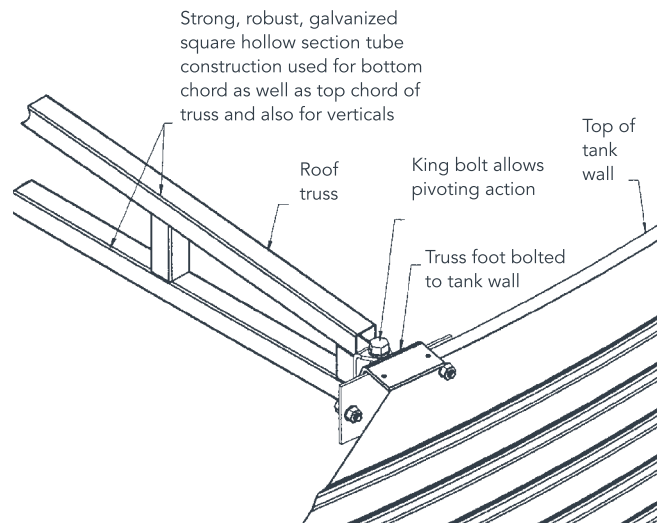

# ROOF OPTIONS: HEAVY DUTY

The heavy duty roof is designed in accordance with the relevant clauses of AS1170.0, AS1170.1 and AS1170.2 to withstand minimum regional winds of up to 43 metres per second.

Embodying the features of the industry standard roof design, the heavy duty tank roof is capable of handling heavier loads arising from larger platforms such as the two metre by two metre roof platform and handrails.

The heavy duty roof has been structurally designed to enable mounting of ancillary features such as a vent hatch on one side of the roof diametrically opposite the access hatch.

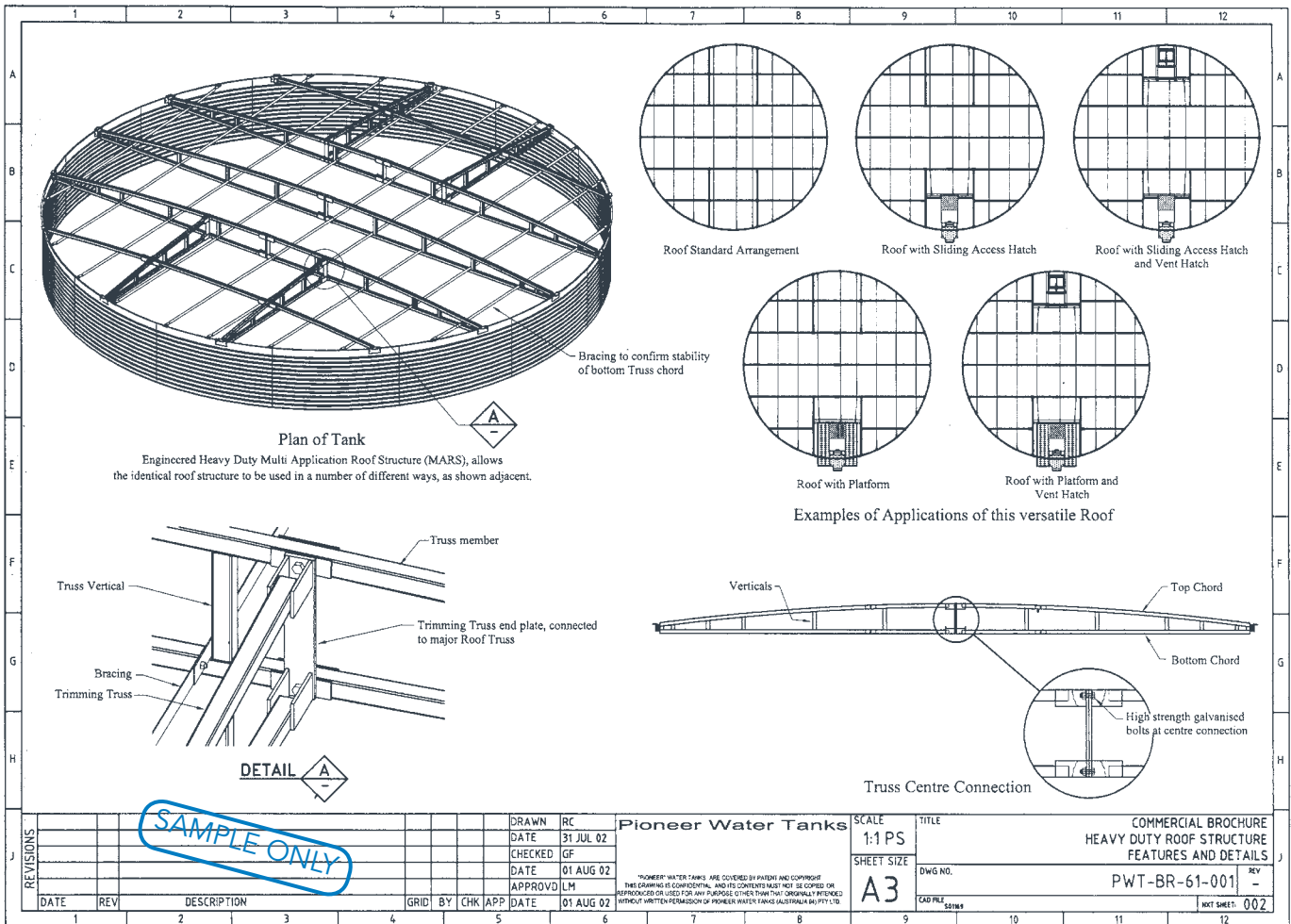

# ROOF OPTIONS: CYCLONIC

Two cyclonic roof designs are available for Cyclonic Regions C and D in accordance with the relevant clauses of AS1170.0, AS1170.1 and AS1170.2.

Regional wind speeds in accordance with AS1170.2 for Region C and Region D cyclonic roofs are 65 metres per second and 82 metres per second respectively.

The cyclonic roofs embodies the features of the heavy duty roof design with roof trusses of greater depth and closer spacing to withstand the higher wind velocities expected in Cyclonic Regions C and D.

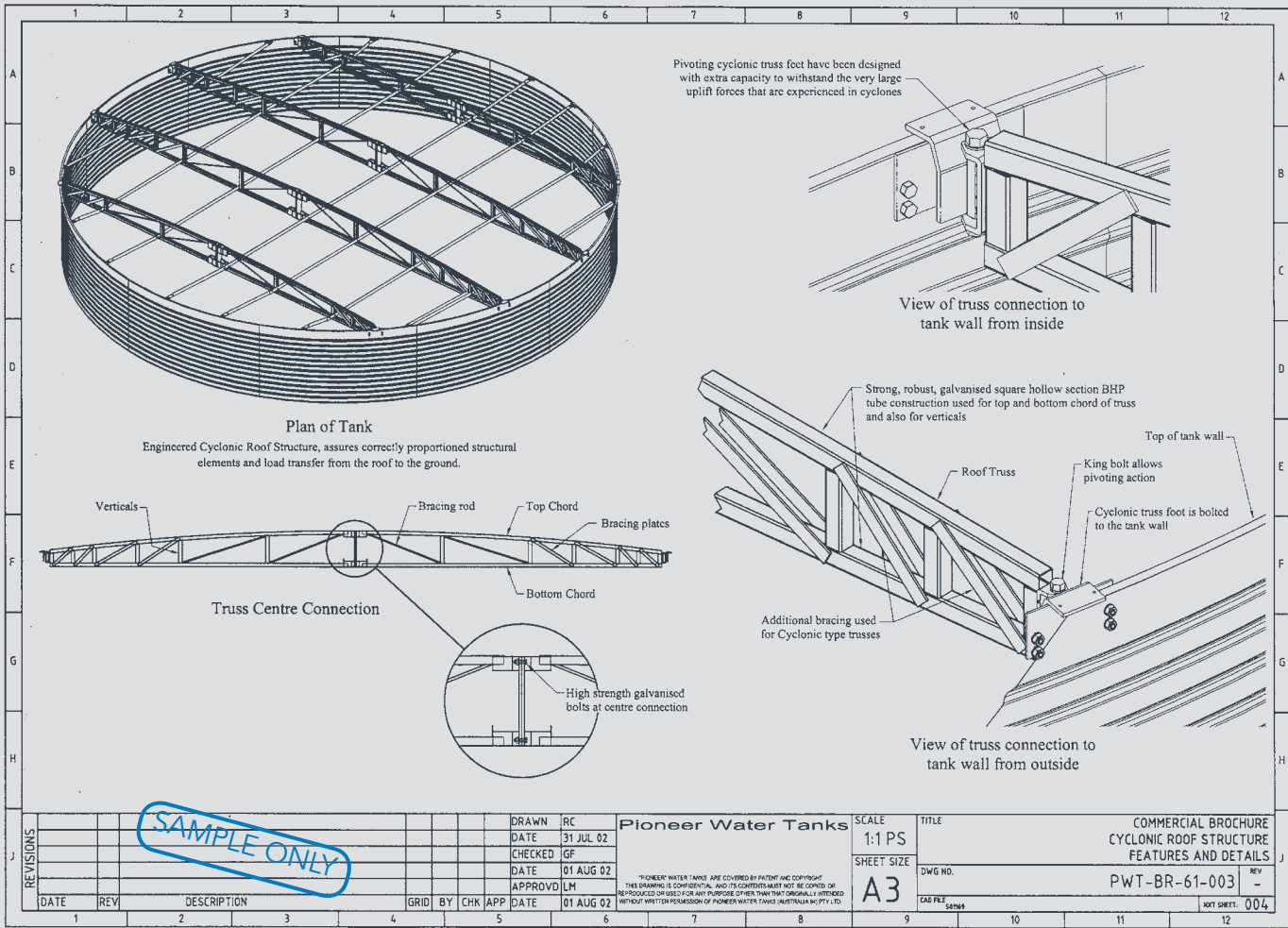

# ROOF OPTIONS - OPEN TOP TANKS

Pioneer Water Tanks have developed a system for tanks without the need for a roof structure.

The open top tank ring truss gives superior strength and stiffness to the top edge of the tank body as shown in the images below.

This simple, but very effective solution works very well for tanks in the effluent treatment industry whereby special ring trusses must be designed to accommodate loads imposed from equipment such as floating aerators.

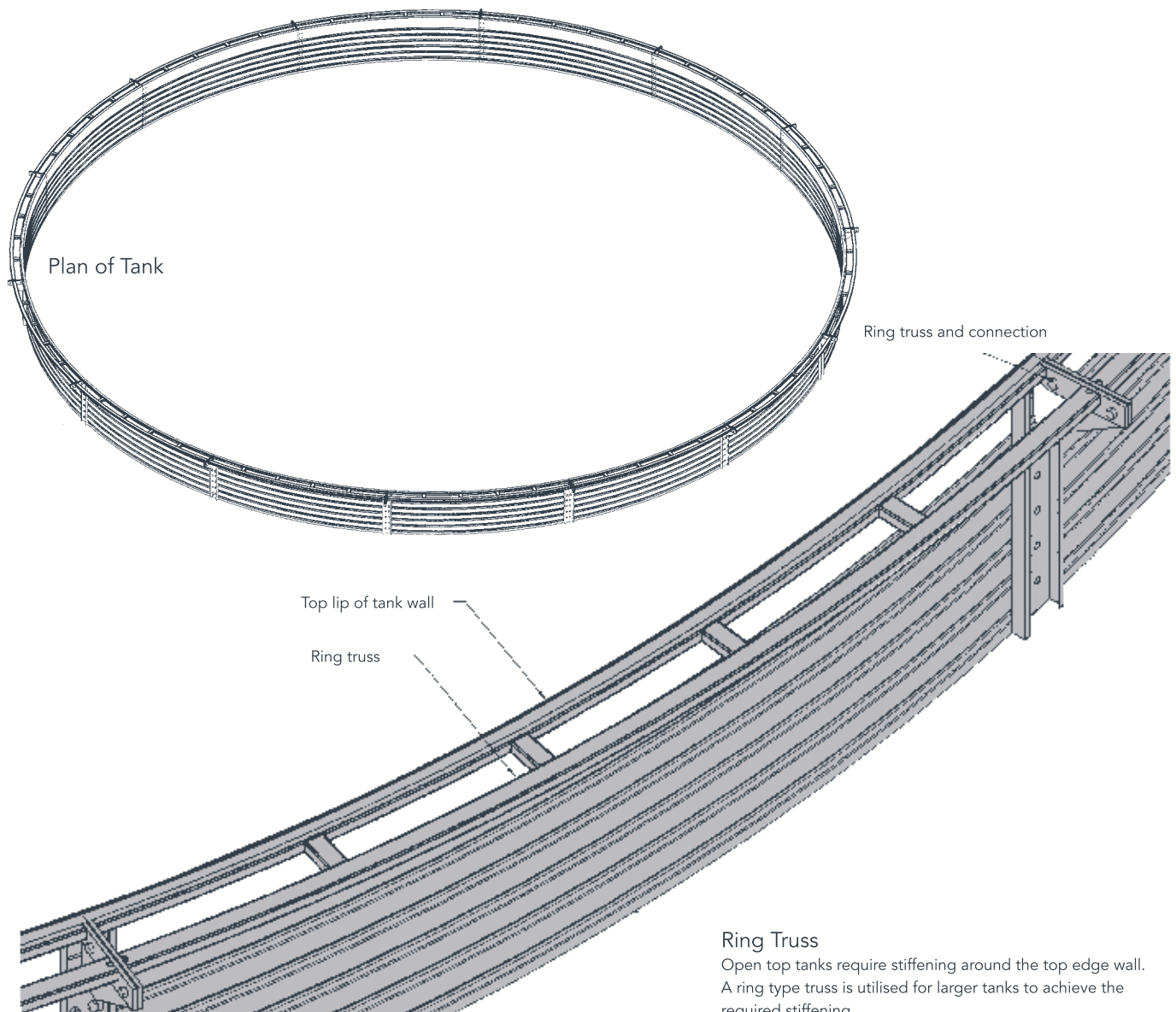

## Ring Truss

Open top tanks require stiffening around the top edge wall. A ring type truss is utilised for larger tanks to achieve the required stiffening.

# NOZZLES AND FITTINGS ORIENTATION

CLIENT ORDER NO.	PIIONEER JOB NO.	TANK SIZE: XL13/03	TANK Ø: 6.02	CUST:
------------------	------------------	--------------------	--------------	-------

EXAMPLE ONLY

NOZZLE SCHEDULE					
NOZZLE	SIZE	Material	Type	DESCRIPTION	External flange
N1	350	HDPE		Inlet c/w Deflector	E
N2	350	HDPE		Overflow c/w Bellmouth	E
N3	350	HDPE		Outlet c/w Vortex Inhibitor	E
N4	100	PVC		Floor Scour Drain	
N5					
N6					
N7					
N8					
N9					

NOZZLE SPECIFICATION DOCUMENT		Revised 12 May 2005
Client:	<b>Notes:</b> Preliminary Drawing, Please confirm nozzle & accessories positioning	Pioneer Water Tanks
Attn:		
Fax:		
Approval: .....		

First Issued	ZINCALUME / COLORBOND®	Revision Date	
	Reference No. <b>CO0000</b>		Revision No.

## Nozzles

Pioneer Water Tanks has the flexibility to insert nozzles through the tank wall, roof or floor to suit most flange tables (BSP, D, E, DN, DIN or ANSI) with polyethylene or galvanized steel fitting also available.

## Valves

Pioneer Water Tanks stocks a selection of valves including ball valves, butterfly valves, float control valves, diaphragm valves, check valves and electronic level sensors.

## Nozzle orientation

The position and size of tank nozzles will determine the effective (or usable) storage capacity of your tank. Clients must nominate the position of each nozzle, inlet, outlet, overflow and the line to match existing or new pipe work prior to manufacture commencing.

The following nozzle orientation drawings are examples of plans that must be approved by the client prior to construction of your tank.

# NOZZLE AND FITTINGS DRAWING SAMPLE

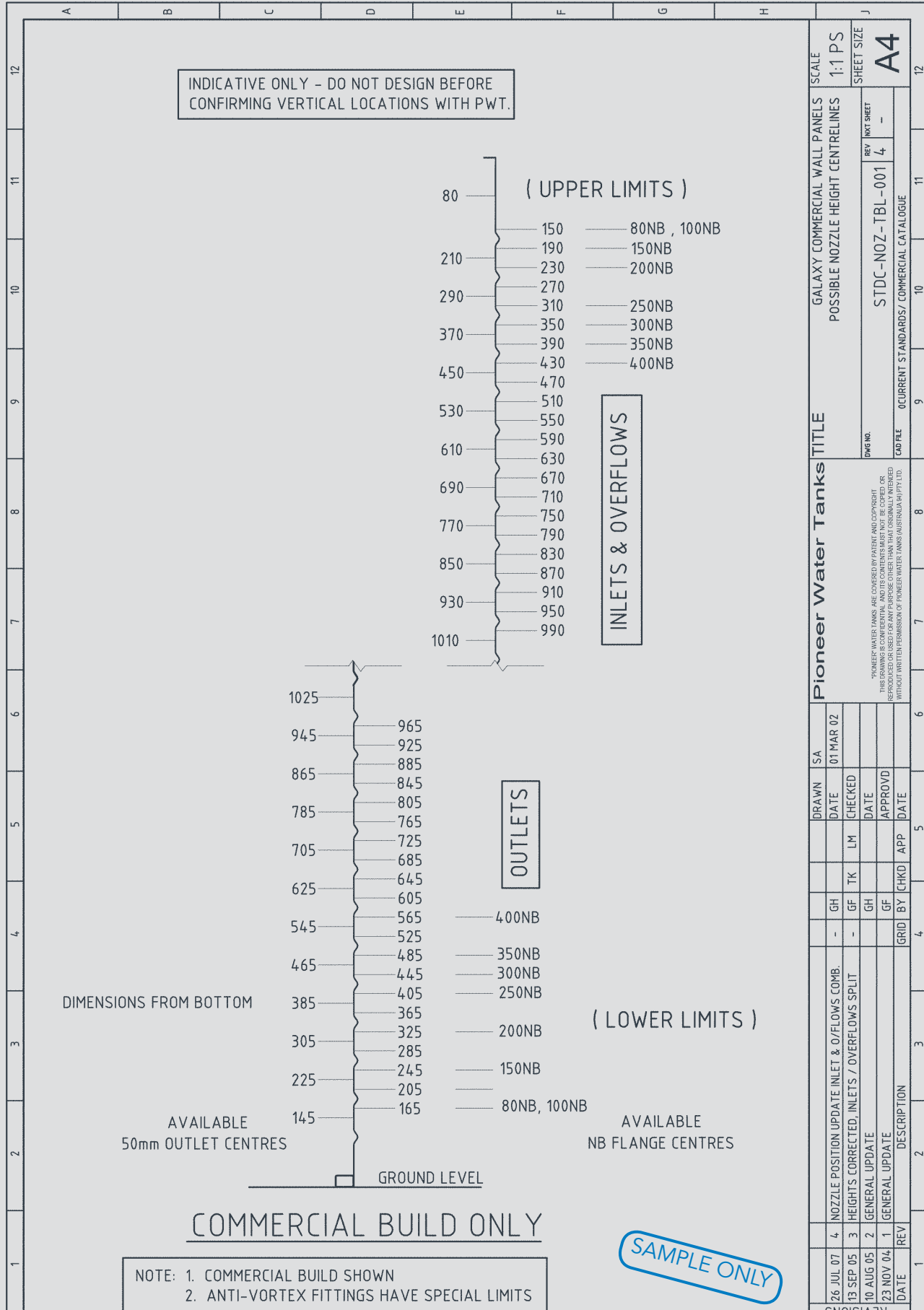



# NOZZLE AND FITTINGS DRAWING SAMPLE

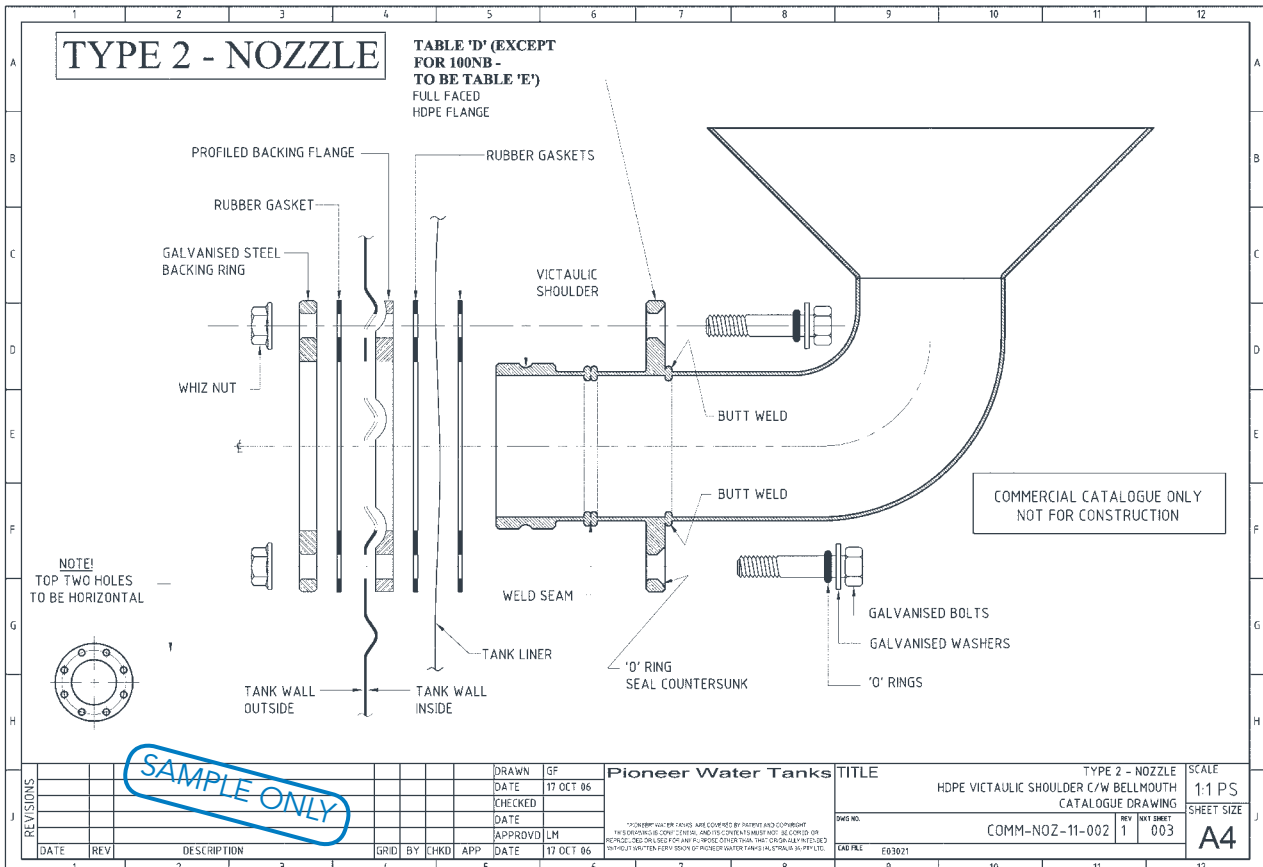
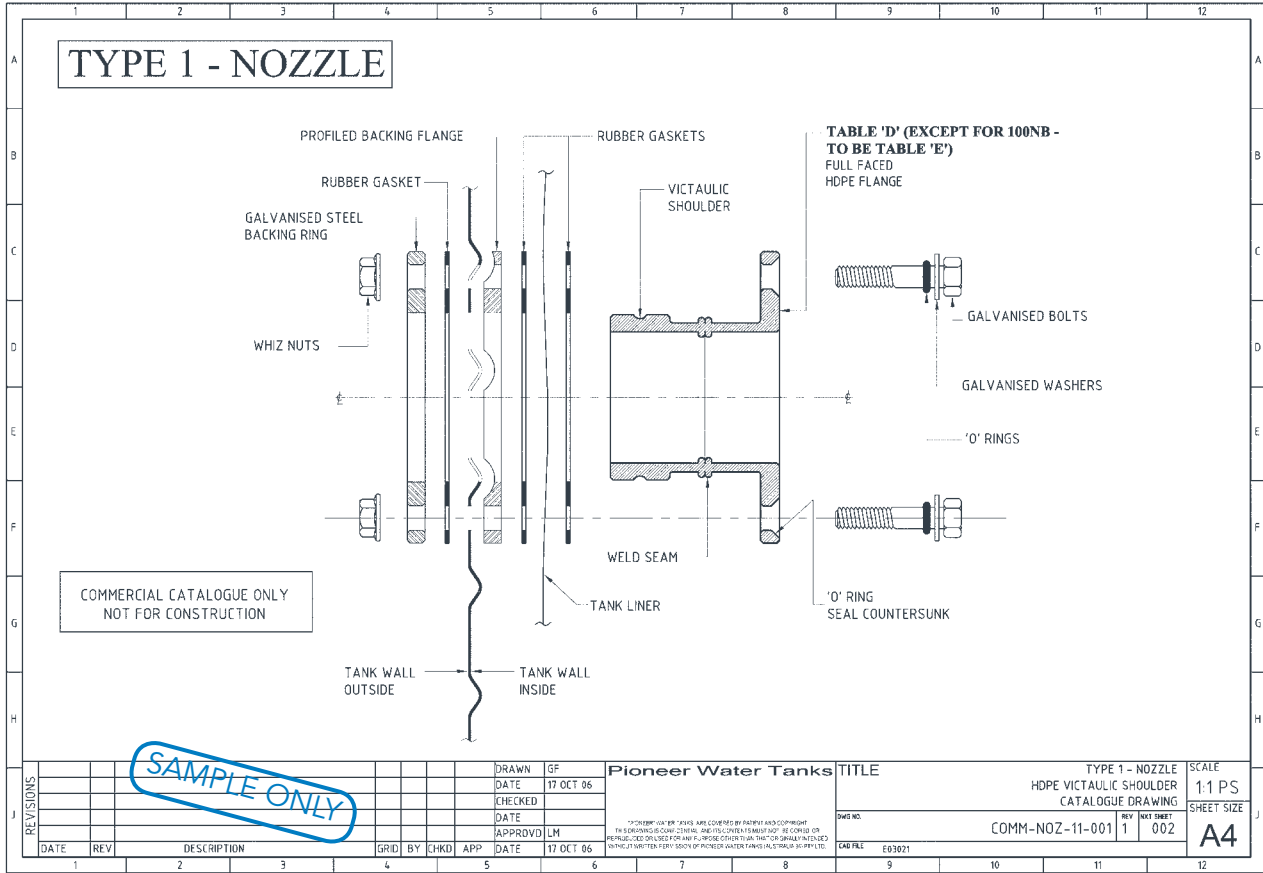

# NOZZLE AND FITTINGS DRAWING SAMPLE

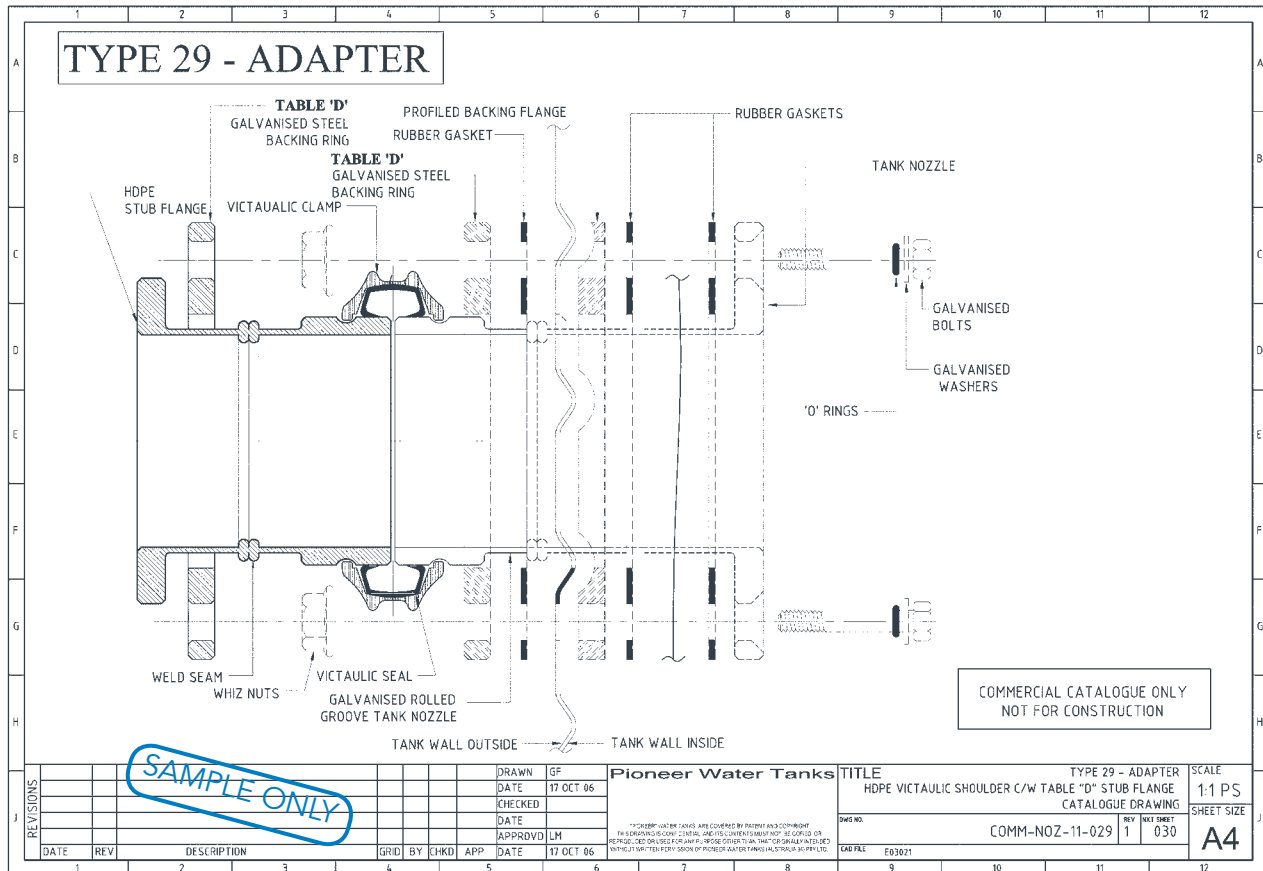
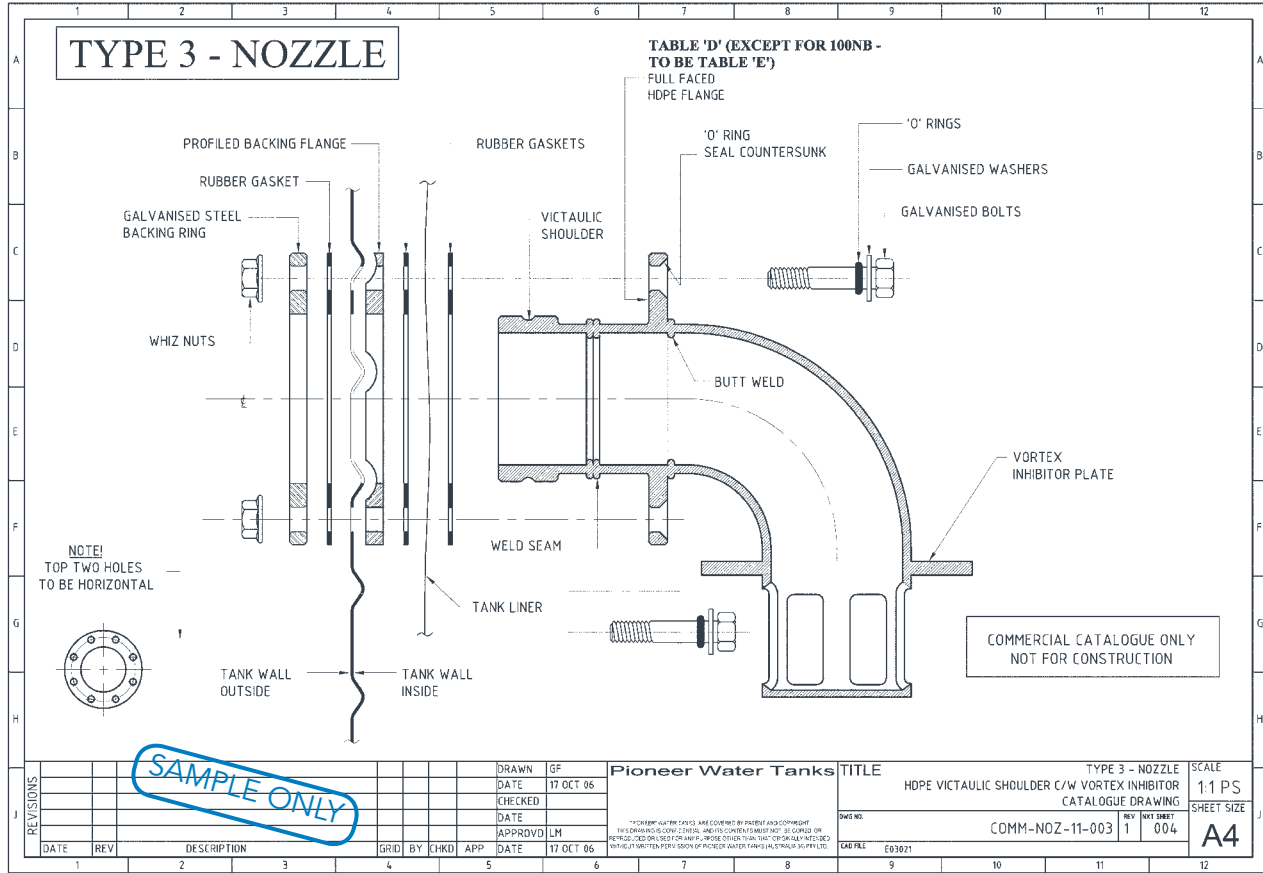

# LADDERS AND ACCESS HATCHES

Pioneer Water Tanks ladders and platforms are specifically designed to suit a range of access requirements.

A range of internal and external ladders have been developed to comply with relevant sections of the LEED, TCEQ and FDEP compliance requirements.

All ladders are hot dipped galvanized or produced in stainless steel, fibreglass, aluminium or powder coated steel.

All commercial style ladders accommodate external and internal platforms, requirements for cages and heights of up to 26 feet. These ladders are designed to connect with either the Pioneer Water Tanks roof platform or commercial sliding access hatch.



# FIXED LADDER DRAWING SAMPLE

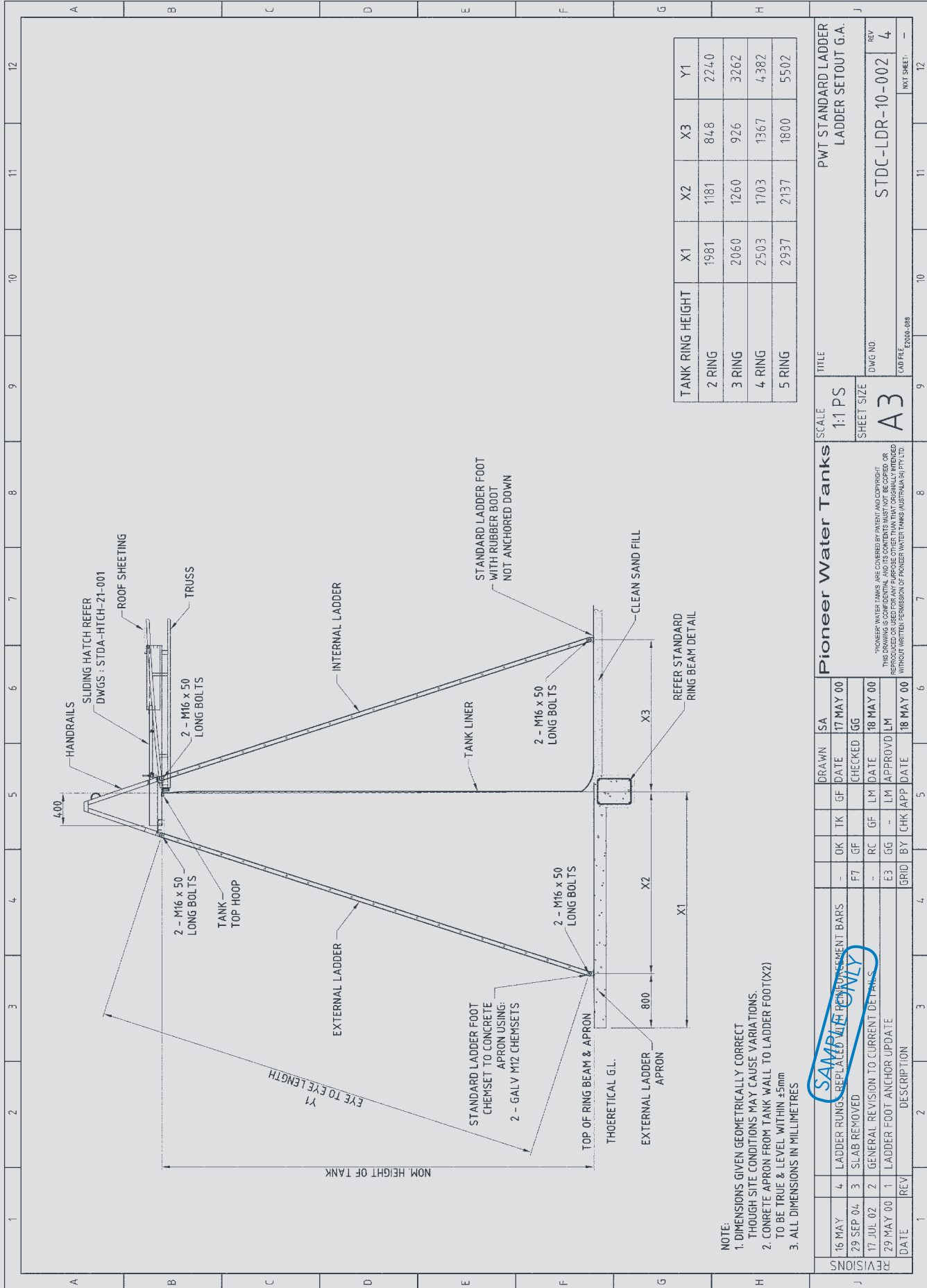

DRAWN		SA	17 MAY 00
OK	TK	GF	CHECKED
F7	GF	LM	18 MAY 00
E3	GG	LM	APPROVED
GRID	BY	CHK	APP
DATE	REV	DESCRIPTION	

**Pioneer Water Tanks**  
 SCALE: 1:1 PS  
 SHEET SIZE: A3  
 TITLE: PWT STANDARD LADDER LADDER SETOUT G.A.  
 DWG NO: STDC-LDR-10-002  
 CAB FILE: L2008-008  
 NWT SHEET: -

POWER WATER TANKS ARE COVERED BY PATENT AND COPYRIGHT.  
 THIS PROJECT OR ANY PART OF IT MUST NOT BE REPRODUCED OR USED FOR ANY PURPOSE OTHER THAN THAT ORIGINALLY INTENDED WITHOUT WRITTEN PERMISSION OF PIONEER WATER TANKS (AUSTRALIA) PTY LTD.

16 MAY	4	LADDER RUNG REPLACED WITH REINFORCEMENT BARS
29 SEP 04	3	SLAB REMOVED
17 JUL 02	2	GENERAL REVISION TO CURRENT DETAILS
29 MAY 00	1	LADDER FOOT ANCHOR UPDATE

# PLATFORM ACCESS HATCH DRAWING SAMPLE

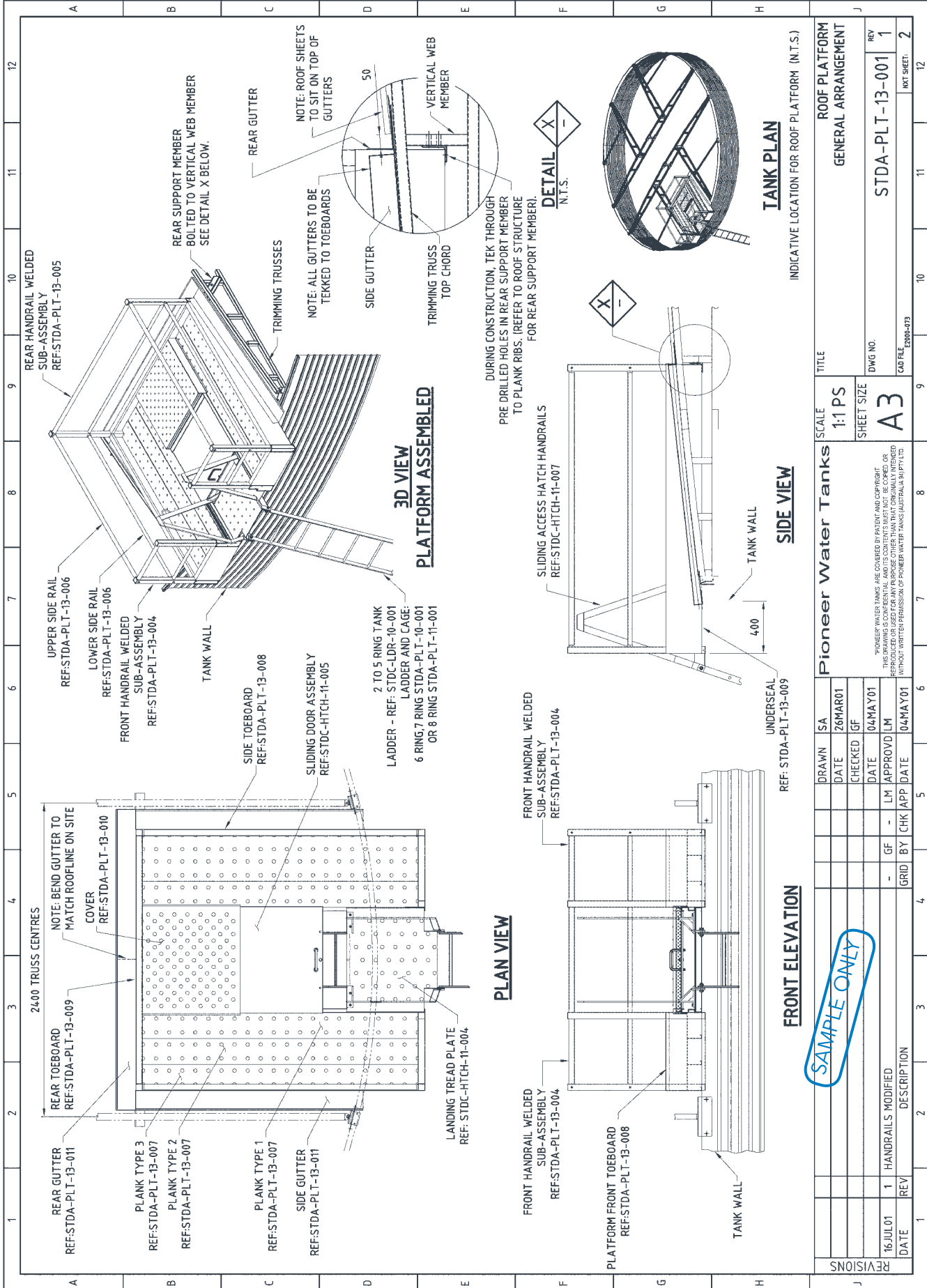

# SLIDING ACCESS HATCH DRAWING SAMPLE

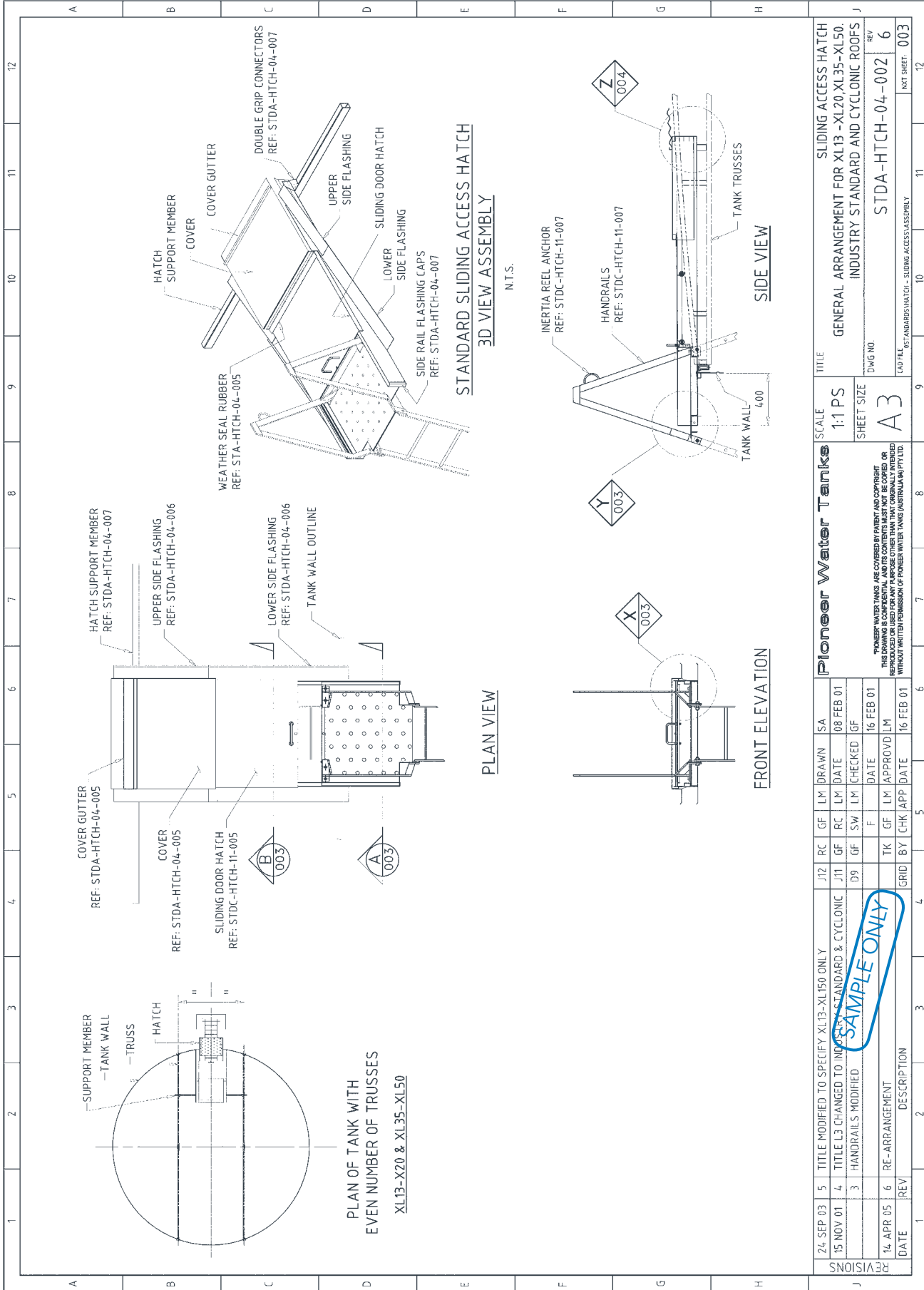

# CHANGE OF DIRECTION PLATFORM DRAWING SAMPLE

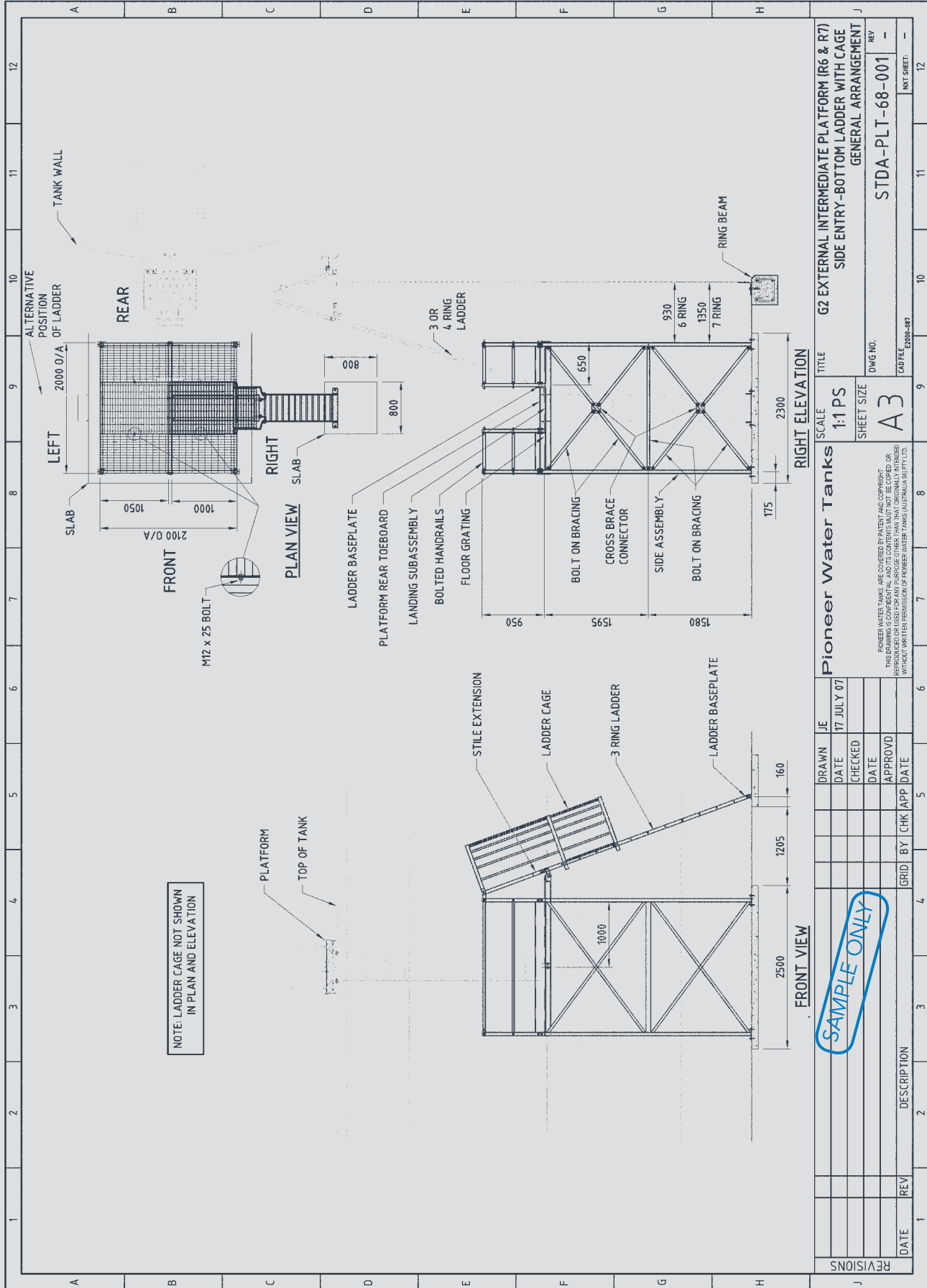

# ACCESSORIES



## Ventilation

Airflow is very important when personnel have to enter the tank for routine maintenance checks or remove airborne pollutants and excess condensation from your tank. Procedures for working in confined spaces are recommended.

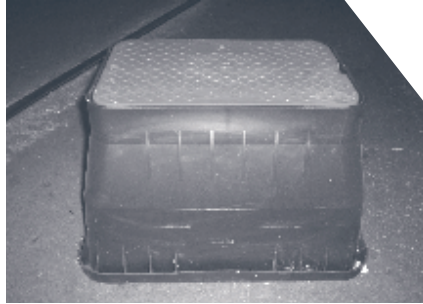

## Scour Box

Protects the scour valve from accidental damage or tampering.

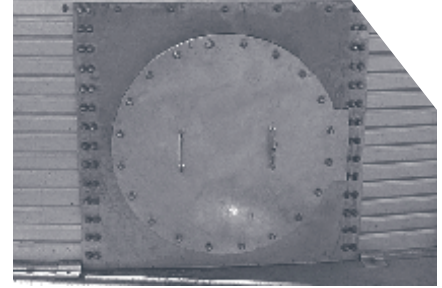

## Side wall access hatch

The side wall access hatch allows access to the inside of the tank from ground level in case of an emergency.



## Pipe brackets

Pipe brackets are used to stabilize external piping. It is the client's responsibility to ensure ground pipework is appropriately supported.

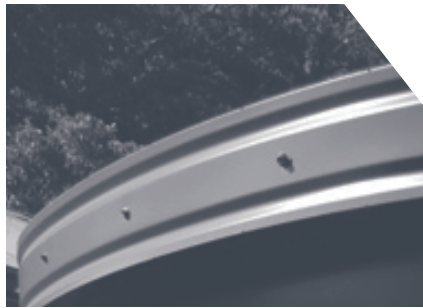

## Fascia

The roof fascia conceals the trimmed edge of the roof sheeting and is ribbed in the same pattern as the wall panels to improve the overall aesthetics of your tank.



## Level indicators

Level indicators can be externally mounted to rural or commercial tanks up to 26 feet in height to display the level of the water within the tank.

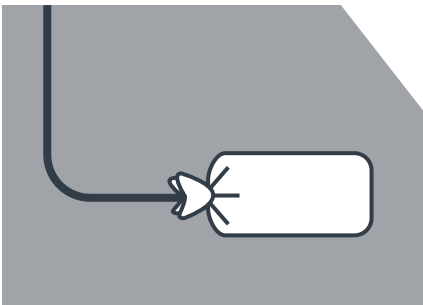

## Anode

Anode: Magnesium alloy

Cable: PVC insulated and sheathed 6mm  $\varnothing$  cross sectional area

Bag material: calico

Back fill mixture:

A premixed backfill surrounds the magnesium block. The ingredients are mixed in the following proportions as required by Australian Standards (AS 2239):

Bentonite 50%

Gypsum 45%

Sodium Sulphate 5%

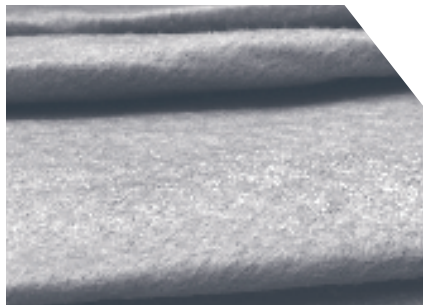

## Geotextile

A 100% polyester non-woven material with high breaking strength. We recommend geotextile when clean sand is difficult to source and protection is required against sharp objects such as stones or rocks that may damage or puncture the liner base.

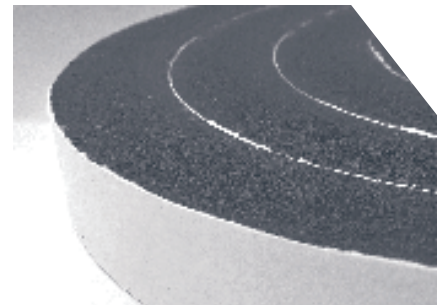

## Dust seals

Protects your stored water from dust, insects and frogs by installing dust seal between the corrugated roof and the top edge of the tank.





# SITE AND FOOTING PREPARATION



## TANK SITE REQUIREMENTS:

- For commercial size tanks, Pioneer Water Tanks requires a concrete ring beam foundation. Some exclusions apply. Please consult Pioneer Water Tanks for more details.
- It is necessary to construct a level area 10 to 13 feet larger than the diameter of the ring beam. The sand inside the ring beam should be a depth of 4 inches and compacted. At least 3.3 feet clear area is required all around the tank for construction.
- Site preparation must be completed prior to the arrival of installers.
- For sloping sites, adequate retaining and drainage must be installed prior to completion of the tank construction. Professional engineering advice should be sought on the retaining and drainage requirements.
- Pioneer Water Tanks guidelines have to be met to prevent re-charges for cost of additional remedial works that may be required. In the event our crew needs to stand down due to delays or incomplete site preparations, additional costs will be incurred by the client.
- Tanks must be commissioned upon completion of construction as per Pioneer Water Tanks commissioning procedures. If your tank has not been commissioned, Pioneer Water Tanks must be consulted prior to the filling of the tank.

# SITE REQUIREMENTS – RING BEAM FOOTINGS

Tank Model	Diameter (feet, inches)	Ring Beam Cross Section : Width x Height (inches)						
		R2	R3	R4	R5	R6	R7	R8
XL01	8' 10"	18" x 10"	18" x 10"	18" x 16"	24" x 16"	26" x 20"	N/A	N/A
XL04	11'	18" x 10"	18" x 10"	18" x 12"	18" x 16"	20" x 20"	24" x 24"	N/A
XL05	13' 2"	18" x 10"	18" x 10"	18" x 12"	18" x 16"	24" x 16"	24" x 24"	N/A
XL08	15' 5"	18" x 10"	18" x 10"	18" x 12"	18" x 16"	20" x 16"	20" x 20"	26" x 20"
XL10	17' 7"	18" x 10"	18" x 10"	18" x 10"	20" x 12"	18" x 16"	24" x 16"	22" x 20"
XL13	19' 9"	18" x 10"	18" x 10"	18" x 10"	18" x 12"	18" x 16"	22" x 16"	20" x 20"
XL15	22'	18" x 10"	18" x 10"	18" x 10"	18" x 12"	18" x 16"	20" x 16"	20" x 20"
XL20	24' 2"	18" x 10"	18" x 10"	18" x 10"	18" x 12"	20" x 12"	18" x 16"	22" x 16"
XL23	26' 4"	18" x 10"	18" x 10"	18" x 10"	18" x 12"	18" x 12"	18" x 16"	20" x 16"
XL25	28' 7"	18" x 10"	18" x 10"	18" x 10"	18" x 12"	18" x 12"	18" x 16"	18" x 16"
XL30	30' 9"	18" x 10"	18" x 10"	18" x 12"	18" x 12"	18" x 12"	18" x 16"	18" x 16"
XL35	32' 11"	18" x 10"	18" x 10"	18" x 12"	18" x 12"	18" x 12"	18" x 12"	18" x 16"
XL40	35' 2"	18" x 10"	18" x 10"	18" x 12"	18" x 12"	18" x 12"	18" x 12"	18" x 16"
XL45	37' 4"	18" x 10"	18" x 10"	18" x 12"	18" x 12"	18" x 12"	20" x 12"	20" x 12"
XL50	39' 6"	18" x 10"	18" x 10"	18" x 12"	18" x 12"	18" x 12"	20" x 12"	18" x 12"
XL60	41' 8"	18" x 12"	18" x 12"	18" x 12"	18" x 12"	18" x 12"	20" x 12"	18" x 12"
XL65	43' 10"	18" x 12"	18" x 12"	18" x 12"	18" x 12"	18" x 12"	20" x 12"	20" x 12"
XL70	46'	18" x 12"	18" x 12"	18" x 12"	18" x 12"	18" x 12"	20" x 12"	20" x 12"
XL80	48' 3"	18" x 12"	18" x 12"	18" x 12"	18" x 12"	20" x 12"	20" x 12"	20" x 12"
XL85	50' 5"	18" x 12"	18" x 12"	18" x 12"	18" x 12"	20" x 12"	20" x 12"	20" x 12"
XL90	52' 8"	18" x 12"	18" x 12"	18" x 12"	18" x 12"	20" x 12"	20" x 12"	20" x 12"
XL100	54' 10"	18" x 12"	18" x 12"	18" x 12"	18" x 12"	20" x 12"	20" x 12"	20" x 12"
XL110	57'	18" x 12"	18" x 12"	18" x 12"	20" x 12"	20" x 12"	20" x 12"	20" x 12"
XL120	59' 2"	18" x 12"	18" x 12"	18" x 12"	20" x 12"	20" x 12"	20" x 12"	20" x 12"
XL130	61' 5"	18" x 12"	18" x 12"	20" x 12"	20" x 12"	20" x 12"	20" x 12"	20" x 12"
XL140	63' 7"	18" x 12"	18" x 12"	20" x 12"	20" x 12"	20" x 12"	20" x 12"	20" x 12"
XL150	65' 9"	18" x 12"	18" x 12"	20" x 12"	20" x 12"	20" x 12"	20" x 12"	20" x 12"

IMPORTANT NOTE: Ring beams can only be built from approved drawings issued by Pioneer Water Tanks.

## RING BEAM FOUNDATION NOTES:

- Ring beam sizes shown are suitable for areas that do not experience cyclonic/seismic conditions. Special designs are required for cyclonic and seismic areas.
- It is very important for the client to ensure that foundation conditions are adequate. These are:
  - safe bearing capacity shall equal or exceed 150kPa.
  - the founding material shall be stable: landfill or active clay may be unsuitable.
- Most sands and gravels that have been compacted to a reasonable level will be adequate provided there is stable soil beneath.
- Should there be any doubt about the stability or strength of the foundation, site-specific professional engineering advice shall be sought by the client.
- If the tank is likely to experience large settlements (eg: softer clay type sites) consideration shall be given to articulated connections for pipework.
- In areas with corrosive soil conditions, special protective measures shall be used (eg: grade N40 concrete and all steel reinforcement galvanized).
- For tanks taller than two rings, Pioneer Water Tanks utilize a jacking system to construct the tank, elevating it one ring at a time. For tanks larger than 238,000 gallons, an additional support bracket is anchored to the vertical face of the ring beam. To ensure this system can be properly employed, it is essential that ring beam specifications are strictly adhered to and that no adjacent concrete is poured prior to jacking. Any unauthorized alterations may inhibit construction and could adversely affect installation of your tank.

# RING BEAM FOOTING DRAWING SAMPLE

PIONEER WATER TANKS RING BEAM DRAWING

FOR INSTALLATION IN TEXAS

XL50-02

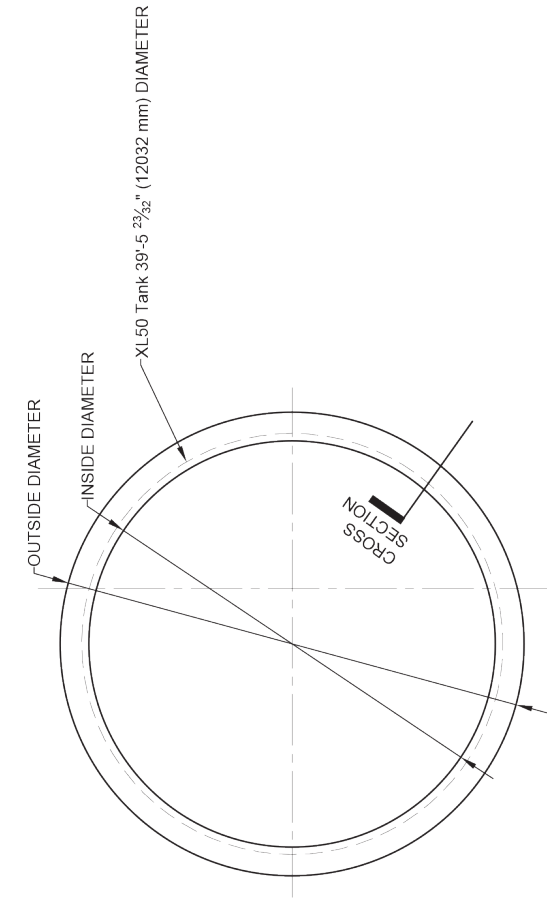

**NOTES:**

1. ALL WORK SHALL BE IN ACCORDANCE WITH THE 2012 INTERNATIONAL BUILDING CODE AND ACI 318-14.
2. CONCRETE SHALL HAVE 28-DAY COMPRESSIVE STRENGTH OF 5,000 PSI.
3. PROVIDE 3 INCH MINIMUM COVER.
4. REINFORCEMENT SHALL CONSIST OF DEFORMED REINFORCING BARS CONFORMING TO ASTM A612, GRADE 60.
5. SUBGRADE AND SAND TO BE STABLE AND COMPACTED. SUBGRADE SHALL HAVE MINIMUM SAFE BEARING CAPACITY OF 3,200 PSF. TOP OF SUBGRADE AND TOP OF SAND SHALL BE LEVEL.
6. DRAINAGE AND ANTI-EROSION MEASURES ON SITE - BY OTHERS.
7. THESE RING BEAM DETAILS SHALL BE USED WITH TANK XL50-02 ONLY. DIFFERENT SIZE TANKS WILL REQUIRE RING BEAMS OF DIFFERENT CROSS SECTION.
8. FORMWORK FOR THE RING BEAM SIDES SHALL CONFORM WITH ACI 318-14. CONCRETE MUST MEET REQUIRED STRENGTH BEFORE CONSTRUCTION AND FINAL LOADS CAN BE APPLIED.
9. SIDE FACES OF RING BEAM SHALL BE FORMED AND NOT CAST AGAINST EARTH.

NOTE: NO SCOUR HAS BEEN SPECIFIED FOR THIS RING BEAM

**DRAWING NTS**

INSIDE DIAMETER = 38'-9 1/2" (11832 mm)  
 OUTSIDE DIAMETER = 41'-9 1/2" (12732 mm)  
 EST RING BEAM VOLUME = 5.86 CY (4.3 m<sup>3</sup>)

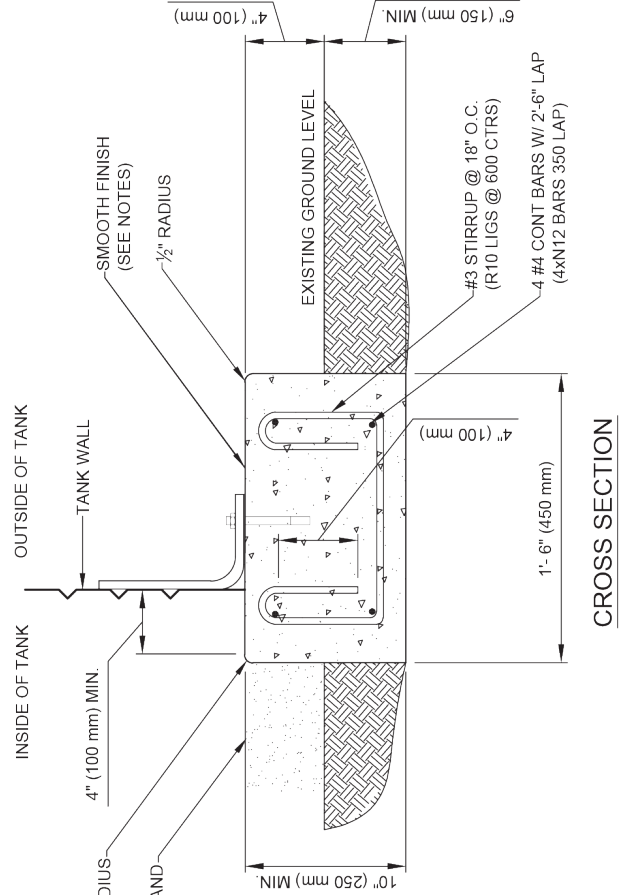

CONSTRUCTION TOLERANCES	
Dimension	Tolerance
Inside Diameter	-3/4" + 0 (-20 mm + 0)
Outside Diameter	-0 + 3/4" (-0 + 20 mm)
Level of top surface	+/- 1/16" over any 5'-0" (+/- 2mm over any 2m) of circumference at tank wall
	+/- 1/8" (+/- 4mm) over entire ring beam

**SAMPLE ONLY**

# PROJECT AND SITE SERVICES

Pioneer Water Tanks can offer a comprehensive range of project and site services for your water storage project.

## Documentation

Sales documentation, contract administration, product specifications and pricing enabling your water storage project to proceed with confidence.

## Project management

Providing comprehensive management and coordination of all aspects of your project for a safe, timely, cost effective delivery and installation.

## Engineering and drafting

Custom designs, detailed drawings and professionally engineered storage solutions.

## Construction

An experienced, efficient and professional installation team highly trained in safe methods of work and disciplined to operate within the strictest client site requirements.

## Civil works

Provision of civil services including tank foundations (such as concrete ring beams).

## Structural works

Including design, fabrication and erection of tank stands, platforms and ladders.

## Plumbing

Supply and installation of pipe-work and fittings associated with your water storage project. Includes provision of automation such as level control and telemetry on water storage tanks.

## Commissioning and maintenance

A comprehensive after-sales service, including full on-site commissioning of your storage tank(s) and the provision of ongoing preventive maintenance services, site inspections and reports.

Internal inspection using Remote Operated Vehicles (ROV) eliminate the need for down time and service interruptions.

Pioneer Water Tanks can provide swift response to rectify damage caused by external unplanned factors or accidents. In the unlikely event of a warranty or performance issue our professional staff will be on-site to provide quick assessment and corrective services.

# OUR REFERENCES

Pioneer Water Tanks' commercial and technical sales team has many years of experience and an intricate knowledge of specialised industrial and commercial project requirements both in Australia and around the world.

Installing in excess of 4,000 water tanks each year World Wide and in over 30 countries, our fast installation time frame and flat packaging for easy transportation are just two of the reasons why our clients have chosen to invest in our tanks.

Following is a partial list of our past projects.

## MINING AND EXPLORATION

- Bounty Mine Forrestania, WA.  
250kL process tank and 100kL potable water tank.
- Pannawonica Mine Site, WA.  
720kL cyclone rated heavy-duty tank.
- Gold mine site, Kalgoorlie, WA.  
500kL process plant tank.
- Cannington silver and lead mine, North QLD.  
1.0mL x2 storage/processing tanks.
- Gold mine, Bendigo, VIC.  
250kL process water tank.
- Nickel mine, QLD.  
363kL chemical treated tank.
- Cullen Valley Mine, NSW.  
219kL raw water storage tank.
- Boddington Gold Mine, WA.  
434kL process water storage tank.
- Iron ore mine, Yandi, WA.  
384kL x4 water storage tanks.
- Ore Body 23, Newman WA.  
1.0mL water storage tank.
- Paraburdoo Iron Ore Mine Site, WA.  
1.14mL x2 process water storage tanks.
- Paraburdoo Iron Ore Mine Site, WA.  
2.6mL process water storage tank.
- Collie Power Station, WA.  
2.18mL process water storage tanks.
- LNG plant, WA.  
27 x 1.0mL fire process water storage tanks.

## COMMERCIAL AND INDUSTRIAL

- WA State Government, York, WA.  
328kL potable storage tank.
- WA State Government, Lancelin, WA.  
294kL x2 potable storage tanks.
- WA State Government, Dalyellup, WA.  
1.3mL potable storage tank.
- WA State Government, Greenhead, WA.  
200kL potable storage tank.

- WA State Government, Sovereign Hill, WA.  
150kL potable storage tank.
- Electricity generation, Tasmania.  
1.0mL potable storage tank.
- Winery, Mt Barker, WA.  
400kL x2 bio-reactor storage tanks.
- Poultry site, Tamworth, NSW.  
1.5mL x2 processing tanks.
- Community water project, Warburton, WA.  
500kL potable storage tank.
- Dairy products processing site, Cobden, VIC.  
250kL x2 effluent storage tanks.
- Victorian State Government (VIC).  
1.27mL reuse water scheme tank.

## FIRE CONTROL

- Fire Safe Systems, Kewdale, WA.  
143kL x4 fire water storage tanks.
- Coal mine, Douglas Park, NSW.  
330kL underground water services tank.
- Food warehouse, Canning Vale, WA.  
300kL x3 fire water storage tanks.
- Meat processing site, Wagga Wagga, NSW.  
250kL x2 fire water storage tanks.
- Building company, NSW.  
323kL potable water storage tank.
- College site, Stanwell Tops, NSW.  
244kL fire water storage tank.
- National electricity retailer, Midland, WA.  
75kL fire service water storage tank.
- Fire solutions provider, Welshpool, WA.  
500kL fire service water storage.

## OVERSEAS EXPORT MARKETS

- Middle East:  
United Arab Emirates, Saudi Arabia, Oman, Qatar, Egypt, Kuwait, Iran.
- South Pacific:  
Cook Islands, Fiji, Tahiti, PNG, Norfolk Island, New Zealand, New Caledonia, Nauru, Samoa, Vanuatu.
- Asia:  
Malaysia, Brunei, Singapore, Thailand, Timor, Indonesia, Myanmar, India, Afghanistan, Maldives, Philippines.
- Africa:  
South Africa, Congo, Zambia, Nigeria, Ghana, Botswana, Namibia, Algeria, Kenya, Ethiopia, Uganda, Liberia, Tanzania, Mozambique, Gabon, Senegal, Comoros.
- South America:  
Chile, Argentina, Peru, Uruguay, Costa Rica, Panama.
- North America:  
USA, Canada, Mexico, Hawaii.
- West Indies:  
Haiti, Santo Domingo.
- Europe:  
Ireland.







Phone: (877) 223-7784

Email: [Info@pioneerwatertanksamerica.com](mailto:Info@pioneerwatertanksamerica.com)

[pioneerwatertanksamerica.com](http://pioneerwatertanksamerica.com)

The information contained in this catalog is provided for informational purposes only and to the fullest extent permitted by law, without any representation or warranty of accuracy or completeness of information or other warranty of any kind including any implied warranty of quality, merchantability, fitness for a particular purpose or non-infringement.

Additionally, Pioneer Water Tanks Pty Ltd ("Pioneer Water Tanks") ABN 65 604 579 651 makes no representation whatsoever, either expressed or implied, in respect of information of third parties that appear in this catalog.

Pioneer Water Tanks®, Aqualiner® and Industratex® are registered trademarks of Pioneer Water Tanks. Colorbond® and Colorbond Ultra® are registered trademarks of Bluescope Steel Ltd. Pioneer is not a designer of water management systems or a consultant in relation to their use. Recipients of this catalog should make their own enquiries about the contents of this catalog and independently verify the applicability, fitness for a particular purpose or suitability or liability with regard to the reliance on or use of any of the information in this catalog or any Pioneer product. Pioneer will not be responsible for the consequences of reliance on any technical advice given by Pioneer employees, appointed distributors or sub contractors in relation to any matter other than those matters specific to the design, manufacture and installation (where applicable) of the Pioneer range of products.

Pioneer will be entitled at any time and without notice to change, update, modify, replace, discontinue, improve and delete any information or product in this catalog.